

$d \leq 3 \text{ cm}$  ✓

$d > 3 \text{ cm}$  ✗

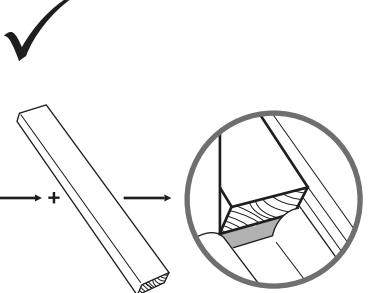

1

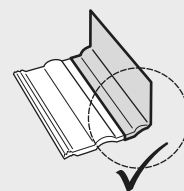
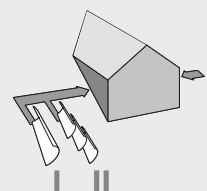
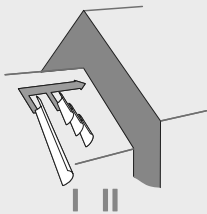

[mm]			
W	w <sub>1</sub>	w <sub>2</sub>	
200	120	80	
250	120	130	
300	130	170	
450	170	280	
900	900		

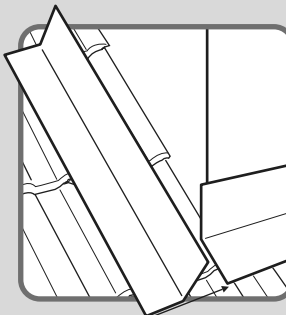
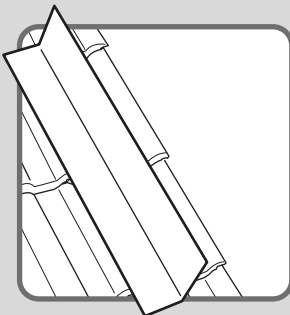
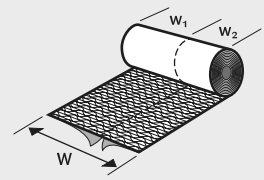

!

	a	b
$\alpha \geq 22^\circ$	$\geq 120 \text{ mm}$	$\geq 80 \text{ mm}$
$\alpha < 22^\circ$	$\geq 120 \text{ mm}$	$\geq 100 \text{ mm}$
$\alpha \geq 10^\circ$	$\geq 120 \text{ mm}$	$\geq 150 \text{ mm}$

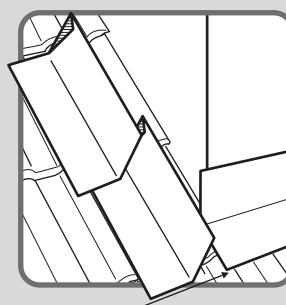
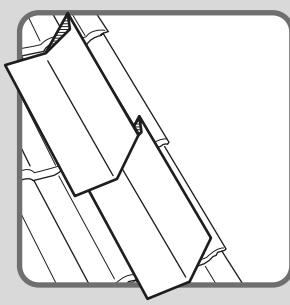

!

	a	b
$\alpha \geq 22^\circ$	$\geq 80 \text{ mm}$	$\geq 80 \text{ mm}$
$\alpha < 22^\circ$	$\geq 80 \text{ mm}$	$\geq 100 \text{ mm}$
$\alpha \geq 5^\circ$	$\geq 80 \text{ mm}$	$\geq 150 \text{ mm}$

2

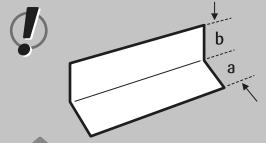
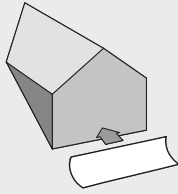

	a	b
$\alpha \geq 22^\circ$	$\geq 100 \text{ mm}$	$\geq 80 \text{ mm}$
$\alpha < 22^\circ$	$\geq 150 \text{ mm}$	$\geq 100 \text{ mm}$
$\alpha < 15^\circ$	$\geq 200 \text{ mm}$	$\geq 100 \text{ mm}$
$\alpha \geq 10^\circ$	$\geq 200 \text{ mm}$	$\geq 150 \text{ mm}$

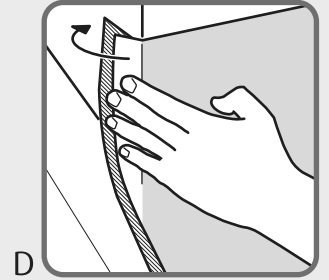
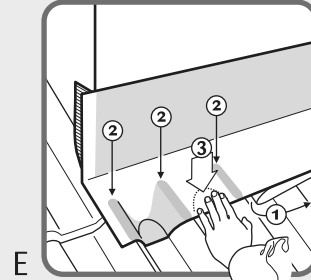
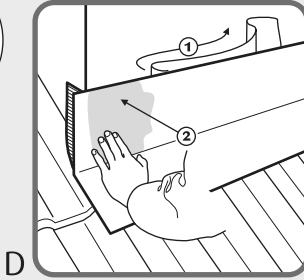
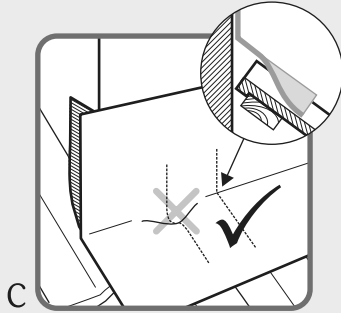
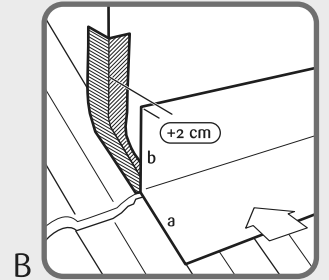
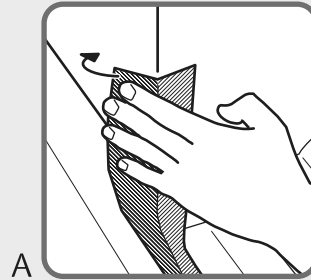

3

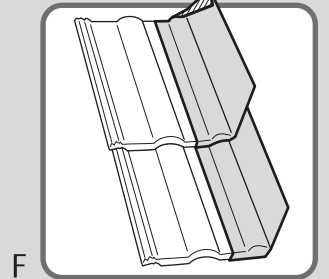
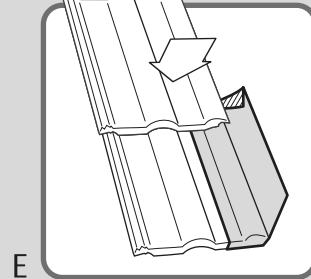
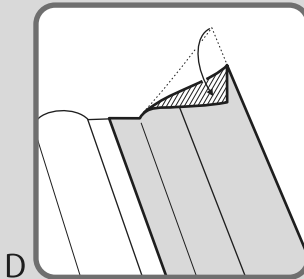
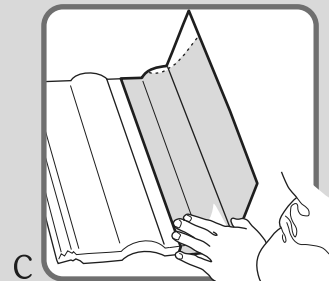
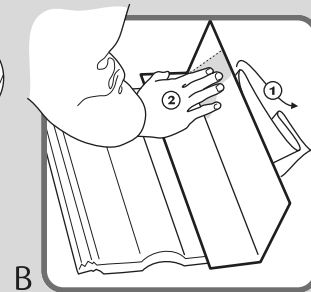
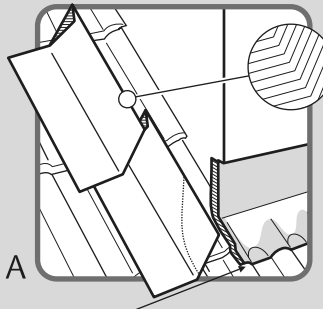
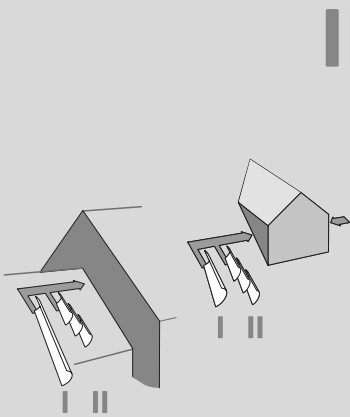
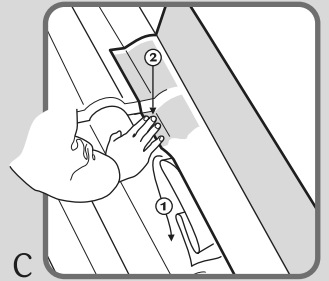
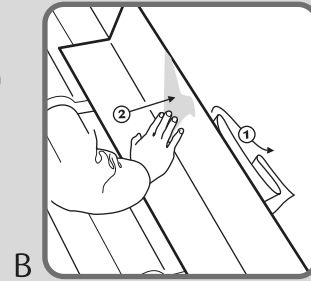
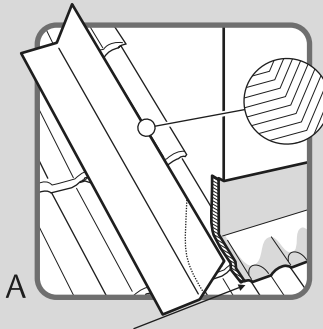
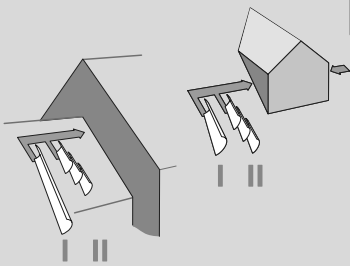

4

